



E65S

ICONIC.INNOVATIVE.POWERFUL





THE KING OF GRINDERS



MAHLKÖNIG E65S



"The E65S produces great-tasting, clean and high-extraction shots. What makes it special though, is that it's designed for super-easy maintenance and cleaning so that the grinder always produces the same high level of quality."

BEN PUT | Barista Champion | Coffee Shop & Roastery Owner

MAHLKÖNIG E65S

DISCOVER THE NEXT GENERATION OF ESPRESSO GRINDING

The MAHLKÖNIG E65S is the perfect synergy of proven premium espresso grinding technology and pioneering features, designed to meet the modern demands of coffee professionals around the globe.

The King of Grinders has equipped the new model with a multifunctional push-and-turn button, an innovative icon menu and presets for up to 6 individually programmable recipes. The slim elegant corpus with a cutting-edge multi-color design features first class components and coatings for a premium look and feel.

But its design pleases more than just the eye: the E65S produces the most pleasant and silent grinding, while its overall construction is robust and well prepared to sustain high workloads. The perfect choice for coffee shops and restaurants.



E65S

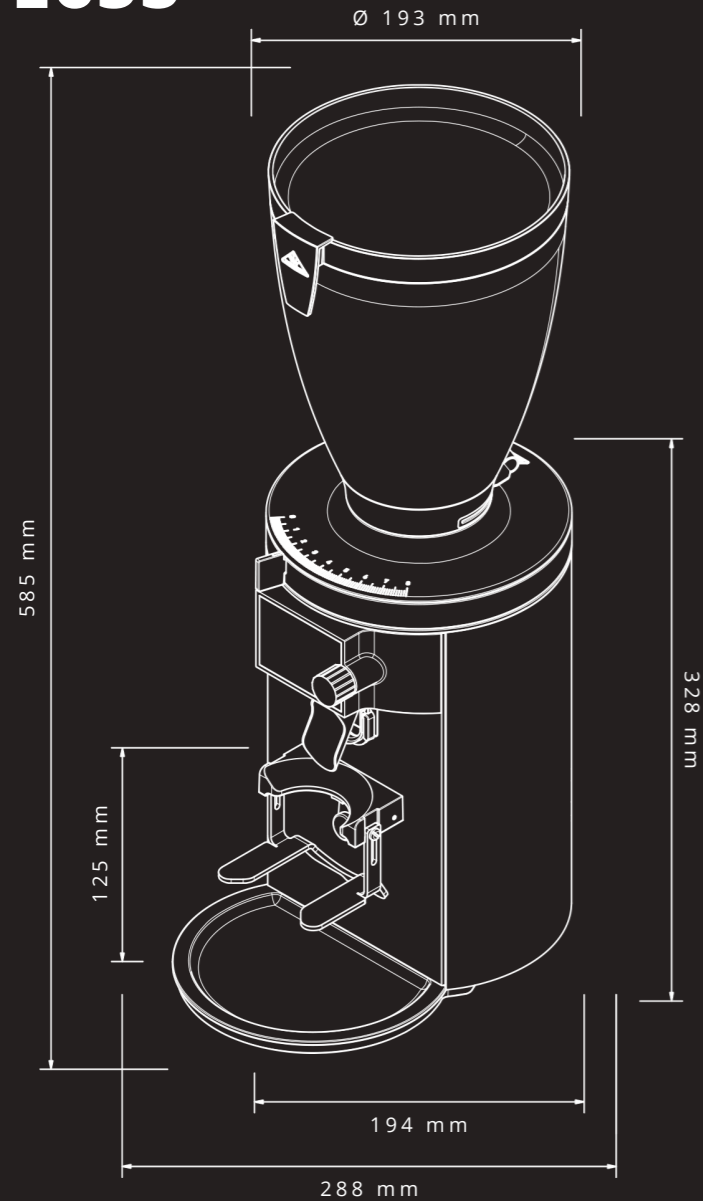

modern slim elegant design

smart clip on lid

indestructible bean hopper

quick and easy grind adjustment

intuitive user interface

proven premium grinding technology

high performance motor

innovative temperature control

precise and impressively-consistent dosing

near-silent grinding

adjustable and removable spout

sturdy portafilter holder and knob

functional magnetic drip tray

small footprint

KEY FEATURES

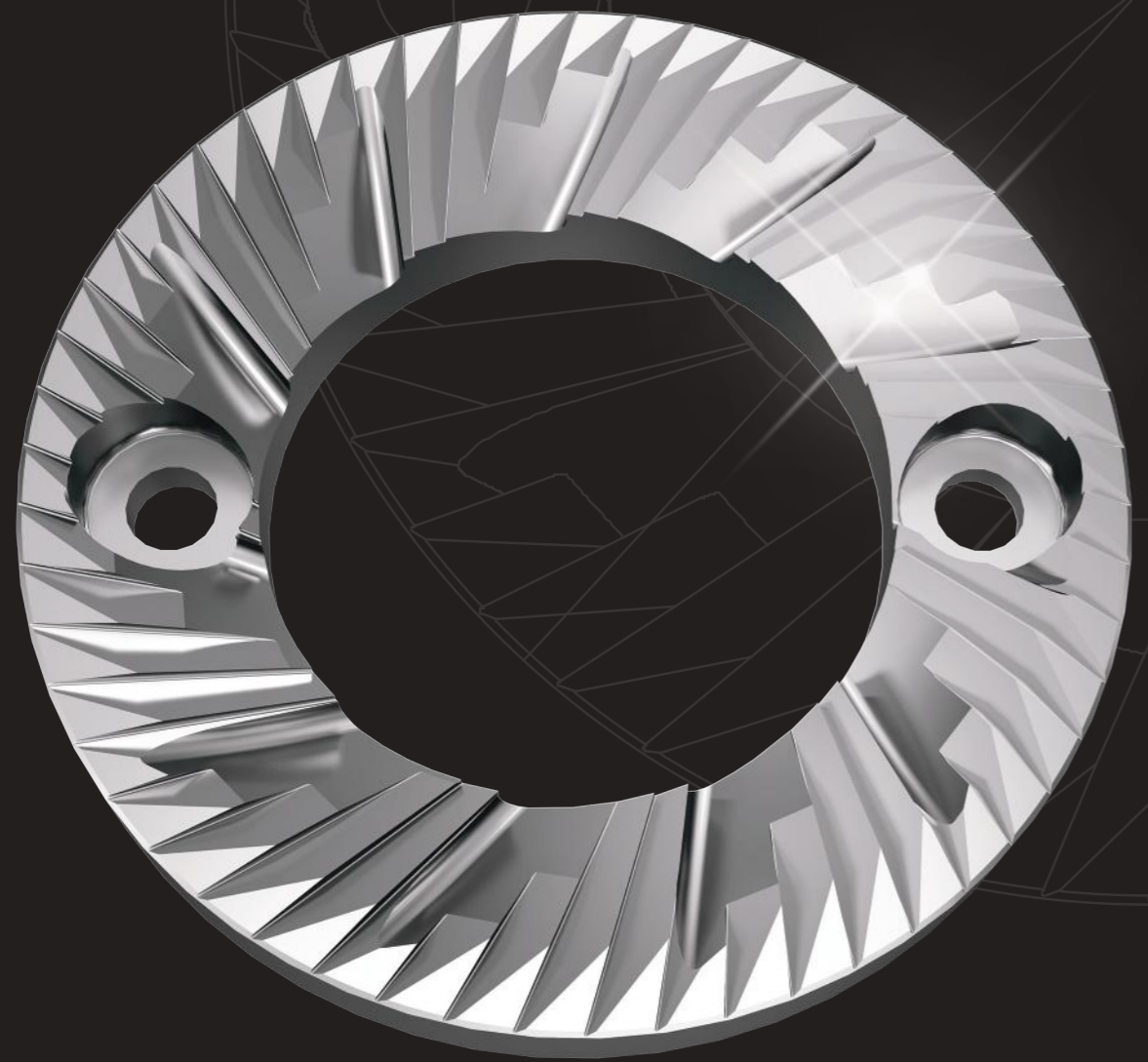

**At the heart of each grinder:
premium grinding technology**

When it comes to manufacturing the centerpiece of grinding, we leave nothing to chance. Hence, we keep the engineering and production departments for our burrs exclusively in-house.

While they are continuously analysing the recent and upcoming requirements of the markets, our engineers make use of their expertise and skills, shaping the innovative spirit of MAHLKÖNIG. Using the latest computer-controlled technology, each burr obtains its individual shape and finishing touch under the watchful eyes of our experienced production team in Hamburg.

Over close to 100 years, MAHLKÖNIG has compiled a comprehensive catalogue of different tooth profiles and grinding surface patterns. We have selected the perfect set of espresso burrs for the E65S. Comprising high-quality hardened steel, each set lasts for between 700-1000 kg of beans, depending on the roast. The sophisticated design of the 65 mm burrs guarantees for the optimal particle size, allowing the espresso to unfold its full taste and aroma.



Precise and consistent dosing is the key to a steady in-cup quality.

The grinding chamber of the E65S cuts retention to a minimum, which not only avoids cross-contaminations of different varieties, but also ensures the most precise dosing consistency. Extensive heavy-duty laboratory tests have shown that the E65S deviates by only 0.4g during an extreme workload cycle of 100 shots straight.



CONSISTENT



PRECISE

Have the precious aroma of your beans protected by the innovative motor temperature control.

MAHLKÖNIG's engineering team has equipped the motor of the E65S with a ground-breaking temperature management system. The smart construction is designed to create an air flow from bottom to top, taking in fresh air that cools down the motor continuously. Furthermore, an integrated fan runs automatically while the E65S is grinding, in order to prevent your espresso beans from any possible negative influence by rising degrees. Even under heavy-duty laboratory tests, where the E65S got to grind 100 shots at a time, the temperature of the ground coffee never reached the 50-degree mark.

The motor is designed to handle high workloads:

Voltage/Freq.	ON/OFF	Duty Cycle (DC)	Performance (DS*=20g)
220-240 V 50/60 Hz	5 s ON/15 s OFF	25 % DC S3* (20 s)	3 DS / min
100 V 50/60 Hz	5 s ON/25 s OFF	16.7 % DC S3* (30 s)	2 DS / min
110-127 V 60 Hz	4 s ON/26 s OFF	13.3 % DC S3* (30 s)	2 DS / min

*1S3: Intermittent periodic duty
*2DS: Double shot



Pioneering grind-adjustment technology lets you set and keep the perfect degree of fineness.

The ultrafine thread inside the grind-adjustment mechanism of the E65S enables utmost precision when it comes to obtaining the right degree of fineness for your espresso beans. The full range reaches from 180 to 580 µm while the scale indicating 80 steps offers meticulous repeatability. An auto-lock system keeps the adjustment in place. However, in case you want to make sure the setting doesn't get changed unintentionally, the grinding degree slide on the backside of the grinder preserves the perfect degree of fineness.

Our revolutionary spout for perfectly-centered espresso grinding.

The re-designed spout adapts to every portafilter within seconds by being simply pushed or pulled into place. Its especially selected anti-static material, honed into a uniquely effective shape, allows the grounds to flow into the portafilter entirely clump free.

Grinding has never sounded so good.

We all want our guests to fully enjoy espresso without disturbance. With this in mind, a team of MAHLKÖNIG engineers and acoustics experts developed the corpus of the E65S with a strong focus on noise reduction and frequency optimization. The sturdy grinder housing, foam-insulated side covers and a special foil behind the front cover reduce and deepen the grinding sound to below 70dBA.



< 70dBA





Changing perceptions: Large display for optimal control.

The E65S features a 2.4" multi-color high contrast display for the most comfortable navigation through the settings, statistics and service alerts.

Set the dose with the ease of a push and a turn of a button.

The multifunctional push-and-turn button lets you navigate through the intuitive icon menu and set the timer within seconds. Offering up to 6 easily programmable recipes, the E65S is well-prepared for even the most varied menu. Once it's time to grind, you simply choose the dose you need, insert the portafilter and the E65S immediately serves the perfect shot of grounds.

Quality leaves nothing to chance.

The E65S software was designed to guarantee smooth workflows at the bar by featuring its preset service alerts and a variety of statistics. The alerts will notify you to clean the grinder with GRINDZ or to exchange the burrs, by calculating the ground volume history. Since a well-maintained grinder guarantees the best taste in every cup, the E65S software will make all the difference.

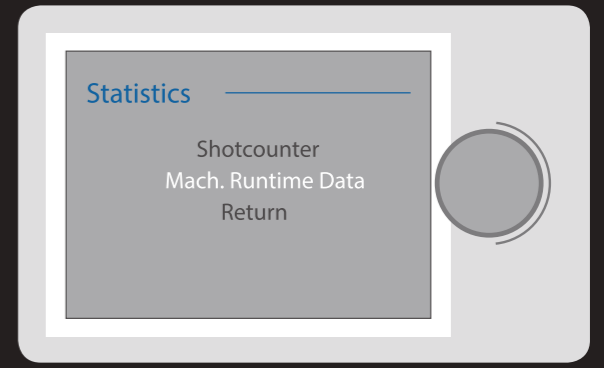



The perfect match for any espresso bar.

The slim corpus design with a small footprint brings outstanding grinding quality even to the tiniest bars. However, with its modern multi-color look the E65S can likewise shine like a star on your spacious counter, demonstrating first-class grinding quality and elegant design.

Whether you are in need of a premium espresso grinder to fit into a very small space or you are looking for an eye-catching highlight to complete your brewing stage: the E65S is made for you.

Stainless steel, matt black

Stainless steel, matt black & white

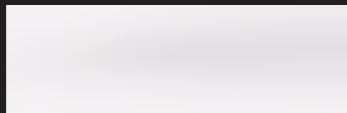
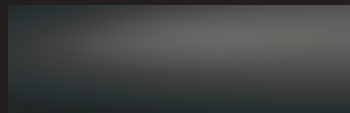

Absolutely indestructible: the bean hopper

The new super-robust bean hopper of the E65S is practically unbreakable. Relying on screws instead of glue points, almost nothing is capable of taking bean hopper and adapter apart and the integrated finger protection inside the bean hopper guarantees safety. Simply fill it up with up to 1.2 kg of beans and start grinding - unless you prefer to use the 350-400 g bean hopper version. The smart clip on the lid of the 1.2 kg bean hopper may hold a note on the blend or specific instructions on the recipes to be kept in mind by the barista.

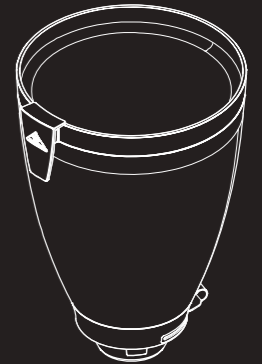

Perfectly adaptable: the portafilter holder

The rocksteady portafilter holder is incredibly easy to adjust by loosening and tightening only two screws in order to make it fit any portafilter. Its sturdy metal sheet and the robust start-stop automation button will neither bend nor bow. They are made to sustain even the busiest of bar time rush hours.

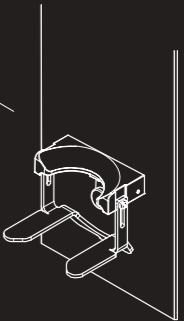

Clean bar counter: the drip tray

The drip tray with its optimal size, shape and position keeps you bar clean and free from unwanted grounds. It is easy to detach, to clean and put back into place as it self-adjusts by slipping onto its holding magnets at the grinder.

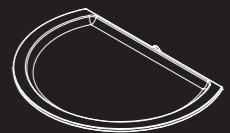



TECHNICAL DETAILS

Voltage // frequencies // phases	100 V // 50 Hz // 1~ 100 V // 60 Hz // 1~ 110 - 127 V // 60 Hz // 1~ 220 - 240 V // 50 Hz // 1~ 220 - 240 V // 60 Hz // 1~
Idle speed	1400 rpm (50 Hz) 1650 rpm (60 Hz)
Burr diameter	65 mm 2.56 in
Burr material	Special steel
Average grinding capacity*	4-7 g/s
Bean hopper capacity	ca. 1200 g 2.64 lb
Max. nominal power	Drive 220 - 240 V: 440 W Drive 100 V: 510 W Drive 110 - 127 V: 580 W
Dimensions (w x h x d)	19.5 x 58.3 x 28.3 cm
Dimensions of packing (w x h x d)	69.7 x 28.7 x 44.5 cm
Net weight	11.2 kg
Gross weight	12.7 kg
Certifications	CE, CB, ETL Safety, ETL Sanitation
Standards	Conforms to: EC/EN 60335-1 IEC/EN 60335-2-64 Certified to: Standard ANSI/UL 763 CSA C22.2 No. 195 NSF / ANSI 8
Standard colors	Stainless steel, matt black Stainless steel, matt black & white

*Depends on the grinding goods and the chosen degree of fineness | All measured values under laboratory conditions

COMPANY OF THE HEMRO GROUP

